

Article number: 021816011146

Description: Clamp with bracket and rubber
SPGU 6011. 146/30 SK

Measures

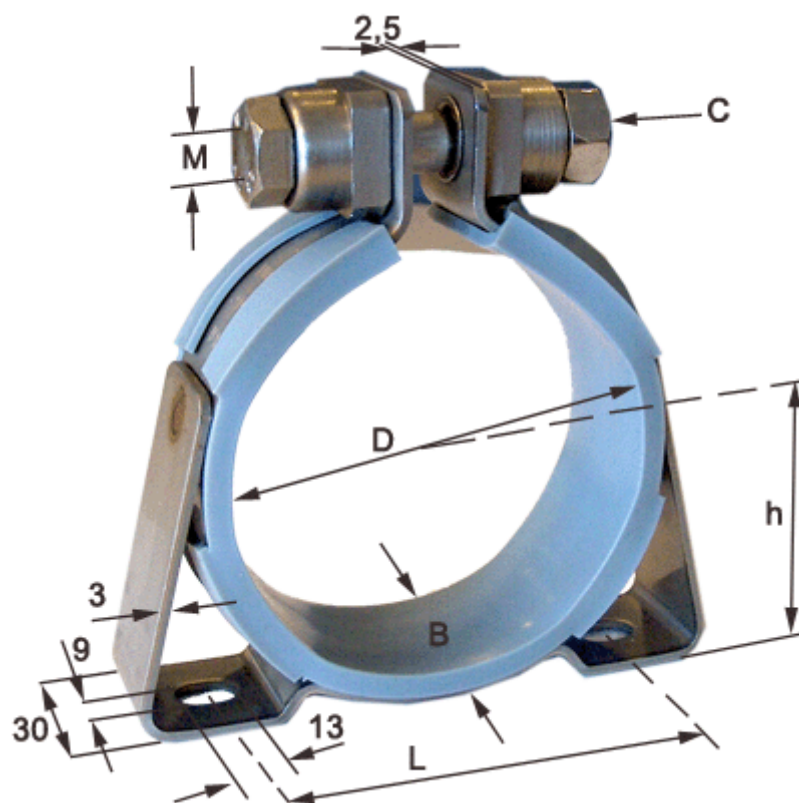

C (screw type) = SK hexagon screw

Diameter D = 146

h = 81

L = 136

Width B = 30